

ZETTLER DISPLAYS

SPECIFICATIONS FOR LIQUID CRYSTAL DISPLAY

CUSTOMER APPROVAL			
※ PART NO. : ATM1010L1K-T (ZETTLER DISPLAYS) TFT SPEC VER1.1			
APPROVAL		COMPANY CHOP	
CUSTOMER COMMENTS			

ZETTLER DISPLAYS ENGINEERING APPROVAL		
DESIGNED BY	CHECKED BY	APPROVED BY
XW	GZC	GuZH

REVISION RECORD

REVISION	REVISION DATE	PAGE	CONTENTS
VER1.0	2023-04-12	--	FIRST ISSUED
VER1.1	2023-03-28	15,16	UPDATE PRECAUTION

※ **CONTENTS**

1. GENERAL SPECIFICATIONS
2. PIN ASSIGNMENT
3. OPERATING SPECIFICATIONS
4. OPTICAL SPECIFICATIONS
5. RELIABILITY TEST
6. PRECAUTION FOR USING LCM
7. MECHANICAL DRAWING
8. PACKAGE DRAWING
9. INSPECTION SPECIFICATION

1. GENERAL SPECIFICATIONS

Item	Specification	Remark
1. LCD size	10.1 inch(Diagonal)	
2. Driver element	a-Si TFT active matrix	
3. Resolution	1280x(RGB)x800	
4. Display mode	Normally black ,IPS, Transmissive	
5. Dot Pitch (W*H)	0.0565mm(W) x 0.1695mm(H)	
6. Pixel pitch(W*H)	0.1695mm(W) x 0.1695mm(H)	
7. Active Area(W*H)	216.96mm(W) x 135.6mm(H)	
8. Module size (W*H)	229.5mm(W) x 149.1mm(H) x 6.6mm(D)	Note 1
9. Surface treatment	Anti-glare	
10. Color arrangement	RGB-stripe	
11. Color	16.7M	
12. Viewing angle (L/R/T/B)	80/80/80/80	
13. Interface	LVDS	
14. LCD controller	EK79202B	
15. LCM brightness	800 cd/m2 (Typ.)	
16. Backlight driving condition	12V (Typ.)	
17. Touch panel	Resistive	
18. Touch controller	Without	
19. Operation temperature	-20~70 °C	
20. Weight	T.B.D	
21. RoHS	ROHS compliant	

Note 1: Please refer to mechanical drawing.

2. PIN ASSIGNMENT

TFT LCD Panel Driving Section

a 40pin connector is used for the module electronics interface.

The recommended model is FH12-40S-0.5SH or other compatible

Pin No.	Symbol	Function	Level	Note
1	NC	No connection	--	
2~3	VDD	Power Supply	P	
4	LVBIT	6-bit(L) / 8-bit(H) input select for LVDS mode.	I	
5	LVFMT	8-bit input format select for LVDS mode H: VESA format (default) L: JEIDA format	I	
6	NC	No connection	--	
7	GND	Ground	P	
8	Rxin0-	-LVDS Differential Data Input	I	
9	Rxin0+	+LVDS Differential Data Input	I	
10	GND	Ground	P	
11	Rxin1-	-LVDS Differential Data Input	I	
12	Rxin1+	+LVDS Differential Data Input	I	
13	GND	Ground	P	
14	Rxin2-	-LVDS Differential Data Input	I	
15	Rxin2+	+LVDS Differential Data Input	I	
16	GND	Ground	P	
17	RxCLK-	-LVDS Differential Clock Input	I	
18	RxCLK+	+LVDS Differential Clock Input	I	
19	GND	Ground	P	
20	Rxin3-	-LVDS Differential Data Input	I	
21	Rxin3+	+LVDS Differential Data Input	I	
22	GND	Ground	P	
23~24	NC	No connection	--	
25	GND	Ground	P	
26	NC	No connection	--	
27	LED_PWM	This pin is connected to the external LED driver	O	
28~30	NC	No connection	--	
31~33	GLED	GND of the LED driver circuit	P	
34	BL_PWM	Backlight PWM control	I	
35	NC	No connection	--	
36	BL_EN	Backlight enable control	I	
37	NC	No connection	--	
38~40	VLED	Backlit circuit power supply (12V)	P	

3. Operating Specification

3.1 ABSOLUTE MAXIMUM RATINGS

Item	Symbol	Values		Unit	Remark
		Min.	Max.		
Power Voltage	V_{DD}	-0.3	3.9	V	
Input Signal Voltage	V_I	-0.3	V_{CC}	V	
Backlight supply voltage	BL_V_{LED}	0.3	15	V	
Operation Temperature	T_{OP}	-20	70	°C	
Storage Temperature	T_{ST}	-30	80	°C	

3.1.1 Typical Operation Conditions

Item	Symbol	Values			Unit	Remark
		Min.	Typ.	Max.		
Power Voltage	V_{DD}	3.0	3.3	3.6	V	Note 2
	BL_V_{LED}	--	12.0	15	V	Note 3
Input Logic High Voltage	V_{IH}	$0.8DV_{DD}$	--	DV_{DD}	V	Note 3
Input Logic Low Voltage	V_{IL}	0	--	$0.2DV_{DD}$	V	Note 3
Current Consumption	I_{VCC}	--	--	--	mA	@white
	$I_{BL-VLED}$	--	--	--	mA	
	$P_{BL-VLED}$	--	--	--	W	
BL_EN / PWM	On/H	1.4	3.3	5	V	
Control Level	Off/L	0	--	0.4	V	
PWM Duty cycle range	D_{PWM}	1		100	%	PWM<50KHz
PWM Control Frequency	f_{PWM}	200	--	200K	Hz	

3.1.2 Backlight Driving Conditions

Item	Symbol	Values			Unit	Remark
		Min.	Typ.	Max.		
Backlight Power	VLED	16.2	18.3	20.4	V	Note 1
Backlight Power	ILED	--	360		mA	VLED=12V
LED life time	--	30000	--	--	Hr	Note 2

Note 1: The Backlight Supply Voltage is defined by the number of LED at Ta=25°C and PWM =100%.

Note 2: The "LED life time" is defined as the module brightness decrease to 50% original brightness at Ta=25°C and PWM =100%.

Fig.5 Forward current VS. Ambient temperature

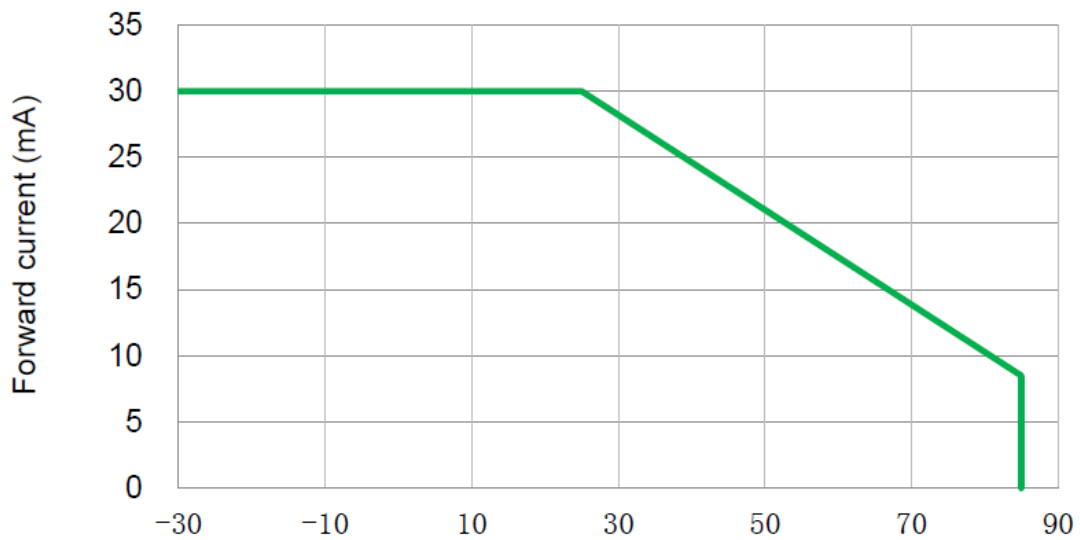

3.2 Power Sequence

a. Power on:

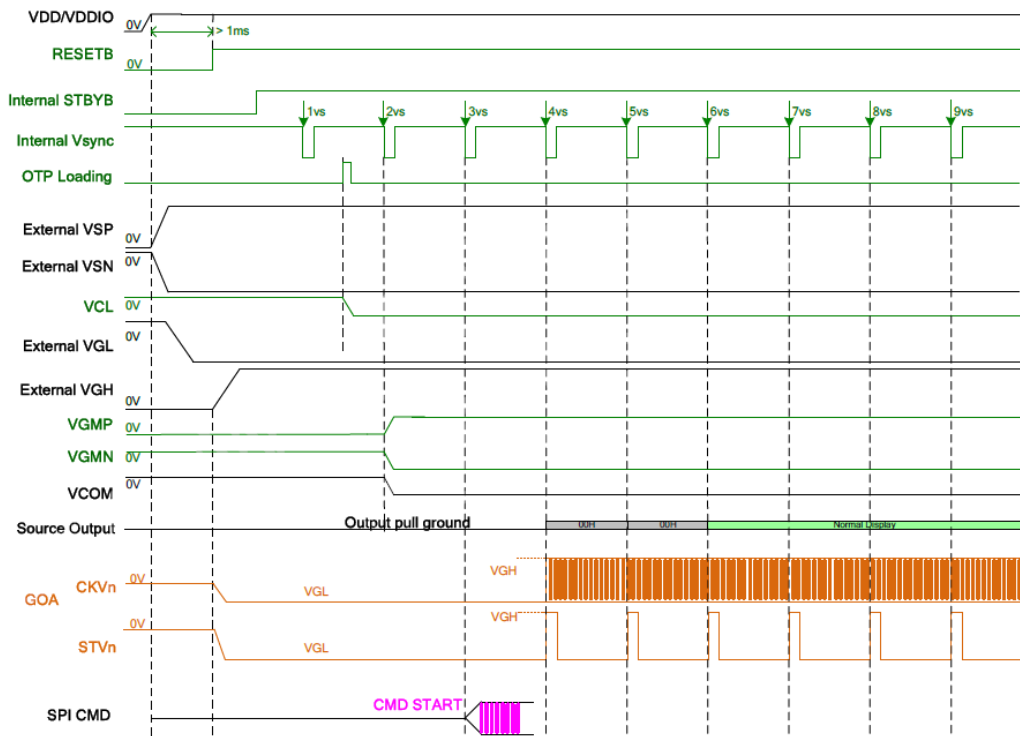

b. Power off:

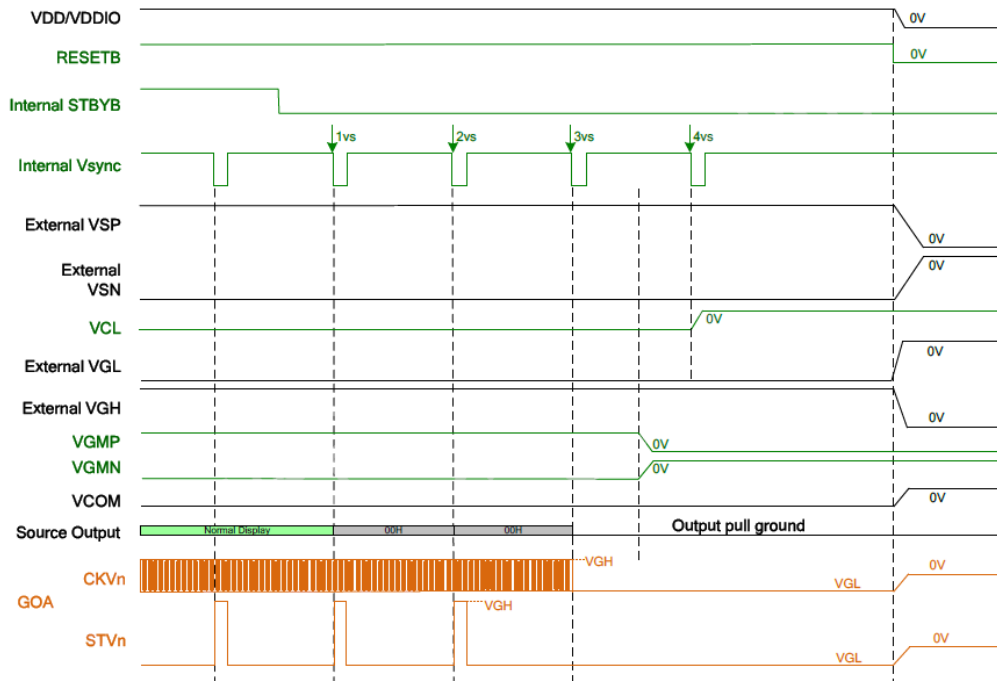

Note: VGH/VGL/VDD/VCOM is the internal voltage of the module, and the timing part is for reference only

3.3 LVDS Signal Timing Characteristics

3.3.1 AC Electrical Characteristics

Item	Symbol	Values			Unit	Remark
		Min.	Typ.	Max.		
Clock frequency	R_{XFCLK}	30	--	T.B.D	MHz	Note 1
Input data skew margin	T_{RSKM}	500	--	--	ps	Note 2
Clock high time	T_{LVCH}	--	$4/(7 \cdot R_{XFCLK})$	--	ns	
Clock low time	T_{LVCL}	--	$3/(7 \cdot R_{XFCLK})$	--	ns	
PLL wake-up time	T_{enPLL}	--	--	150	us	

Note 1: Refer to input timing table for each display resolution

Note 2: $|VID|=200mV$, $R_{XVCM}=1.2V$, $R_{XFCLK}=81MHz$;

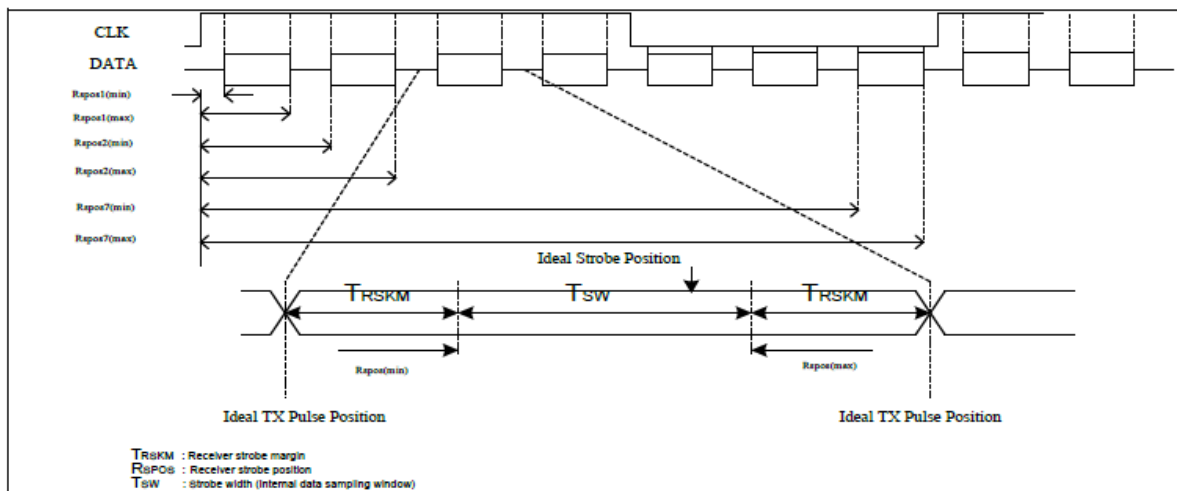
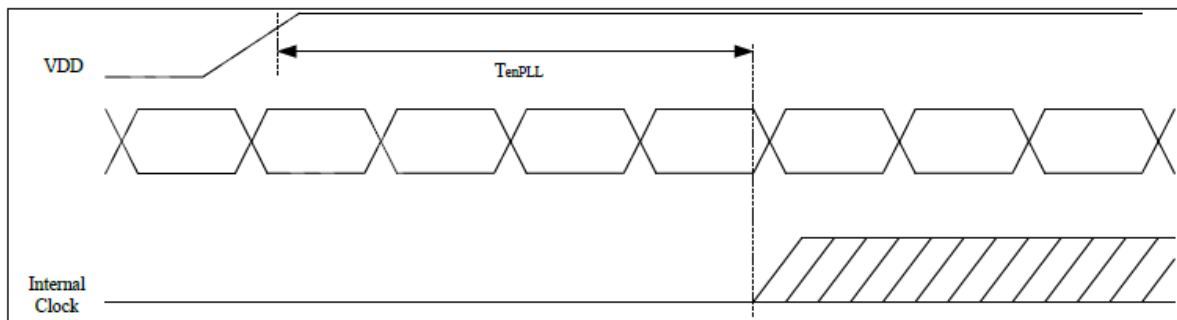
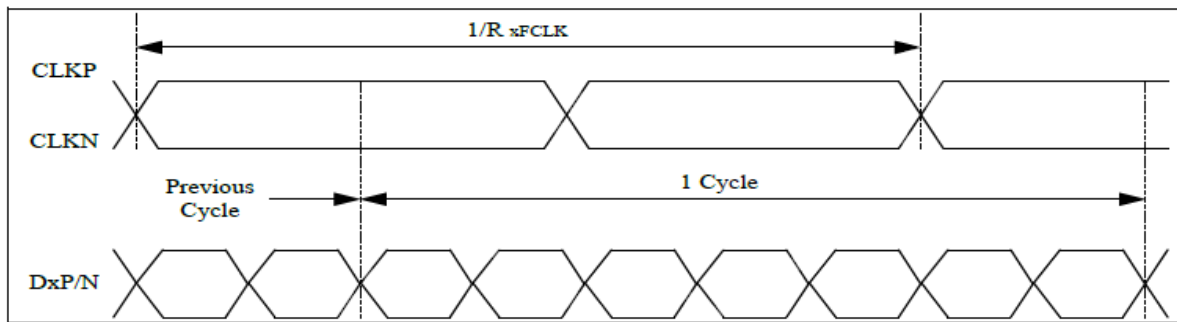

3.3.2 Timing Table

Parameter	Symbol	Value			Unit
		Min.	Typ.	Max.	
DCLK frequency @Frame rate=60Hz (LVDS)	F _{DCLK}	66.3	72.4	78.9	MHz
HSYNC period time	T _H	1380	1440	1500	DCLK
Horizontal display area	T _{HD}	1280			DCLK
HSYNC pulse width	Min.	2			
	Typ.	-			
	Max.	40			
HSYNC back porch(with pulse width)	T _{HBP}	88	88	88	DCLK
HSYNC front porch	T _{HFP}	12	72	132	DCLK
VSYNC period time	T _V	824	838	872	H
Vertical display area	T _{VD}	800			H
VSYNC pulse width	Min.	2			H
	Typ.	-			
	Max.	20			
VSYNC back porch(with pulse width)	T _{VBP}	23	23	23	H
VSYNC front porch	T _{VFP}	1	15	49	H

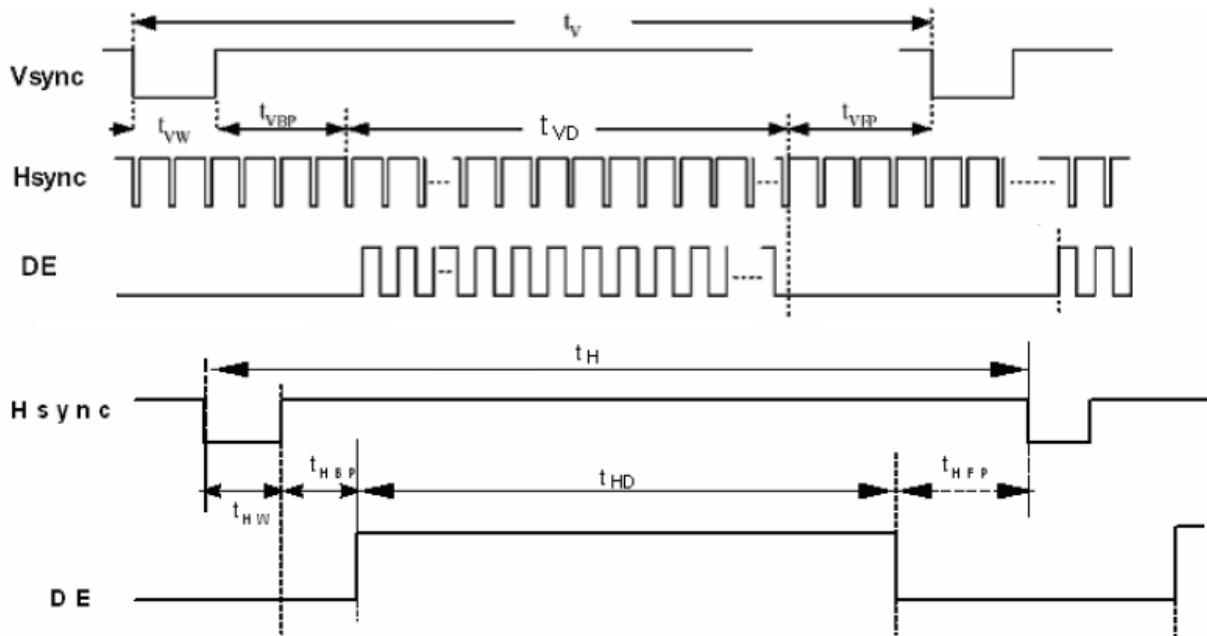

3.3.3 LVDS Data Input Format

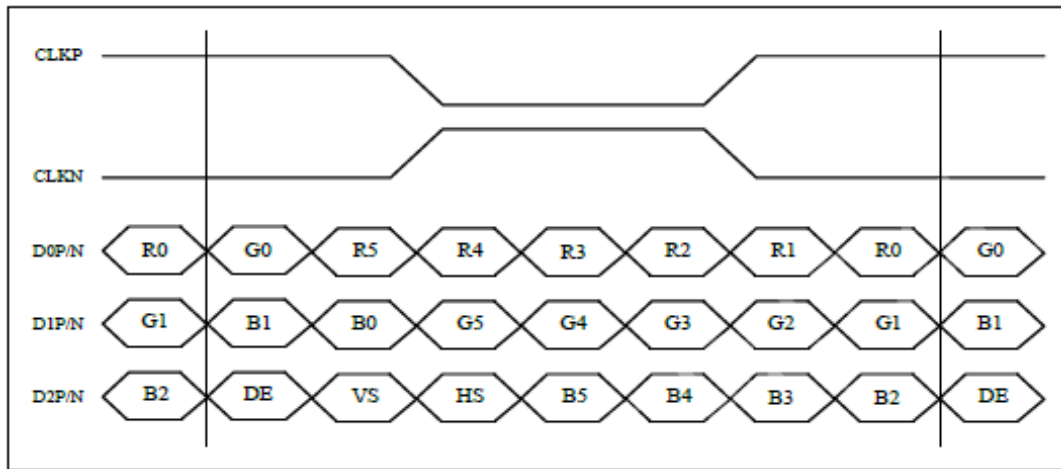

6-bit LVDS input (LVBIT=L, LVFMT=Don't care)

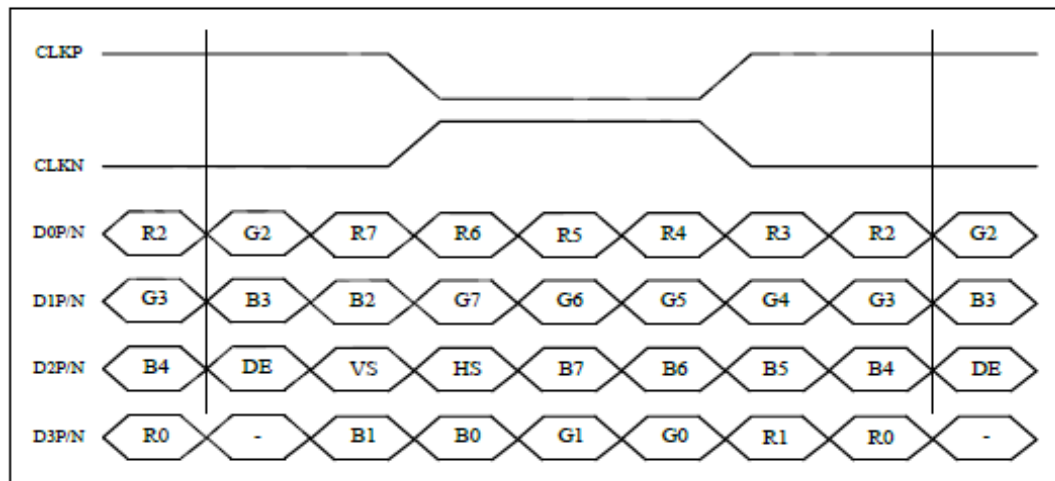

8-bit LVDS input (LVBIT=H, LVFMT=L)

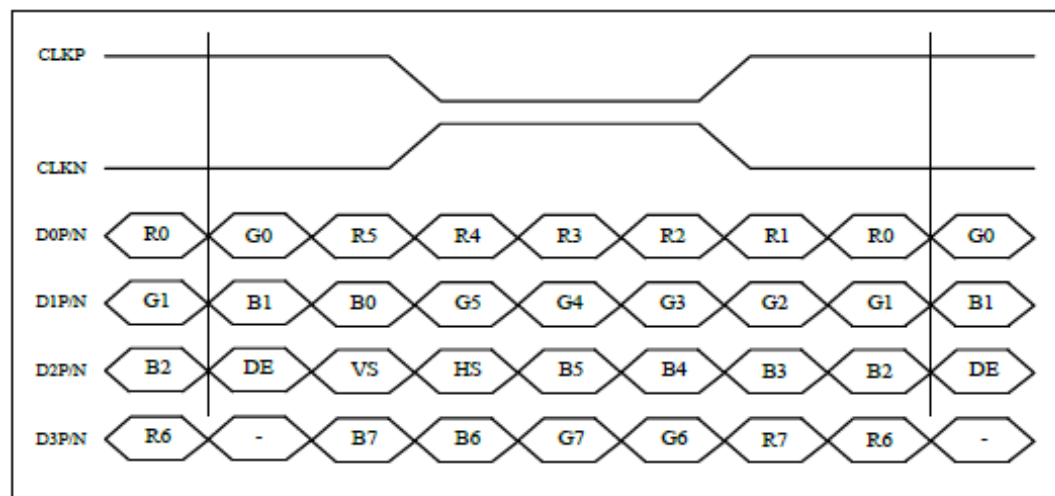

8-bit LVDS input(LVBIT=H, LVFMT=H)

4.0 OPTICAL SPECIFICATIONS

Item	Symbol	Condition	Values			Unit	Remark
			Min.	Typ.	Max.		
Viewing Angle (CR ≥ 10)	θ_L	$\Phi=180^\circ$ (9 O'CLOCK)	--	80	--	degree	Note 1
	θ_R	$\Phi=0^\circ$ (3 O'CLOCK)	--	80	--		
	θ_T	$\Phi=90^\circ$ (12 O'CLOCK)	--	80	--		
	θ_B	$\Phi=270^\circ$ (6 O'CLOCK)	--	80	--		
Response Time	T_{ON}	Normal $\Theta=\Phi=0^\circ$	--	10	20	msec	Note 3
	T_{OFF}		--	15	30	msec	Note 3
Contrast Ratio	CR		--	800	--	--	Note 4
Color Chromaticity	W_X		0.25	0.30	0.35	--	Note 2,5,6
	W_Y		0.26	0.31	0.36	--	
Luminance	L		700	800	--	cd/m ²	Note 6
Luminance Uniformity	YU		75	--	--	%	Note 7

Test Conditions:

1. The ambient temperature is 25°C.
2. The test systems refer to Note 2.

Note 1: Definition of viewing angle range

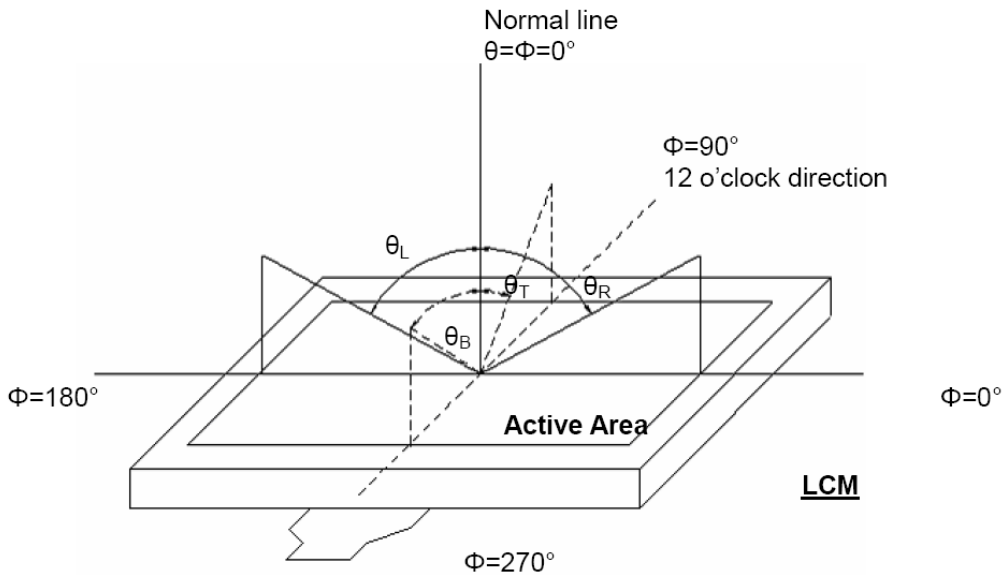

Figure 4.1 Definition of viewing angle.

Note 2: Definition of optical measurement system.

The optical characteristics should be measured in dark room. After 30 minutes operation, the optical properties are measured at the center point of the LCD screen. (Response time is measured by Photo detector TOPCON)

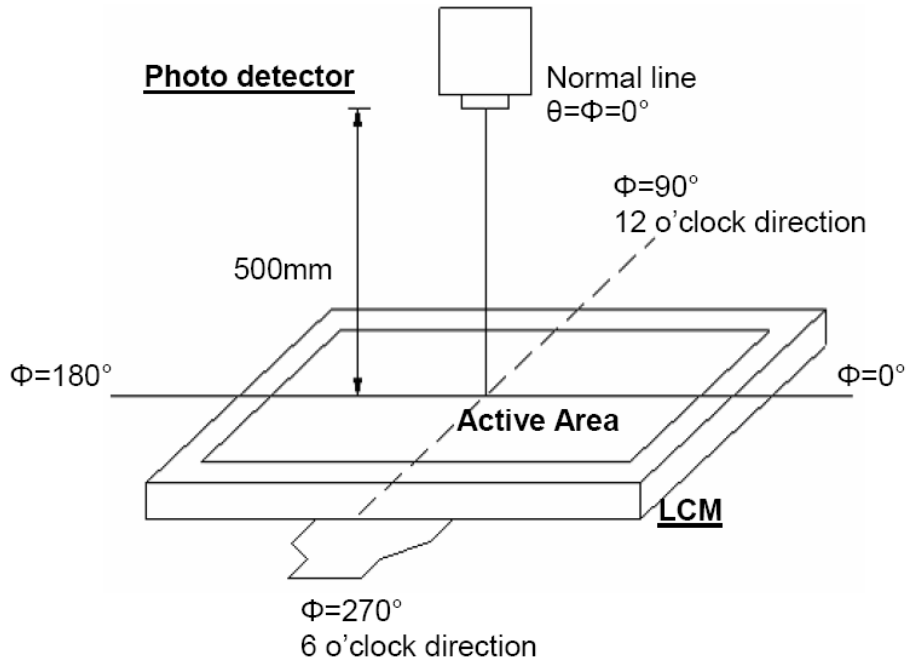

Figure 4.2 Optical measurement system setup

Note 3: Definition of Response time

The response time is defined as the LCD optical switching time interval between "White" state and "Black" state. Rise time (TON) is the time between photo detector output intensity changed from 90% to 10%. And fall time (TOFF) is the time between photo detector output intensity changed from 10% to 90%.

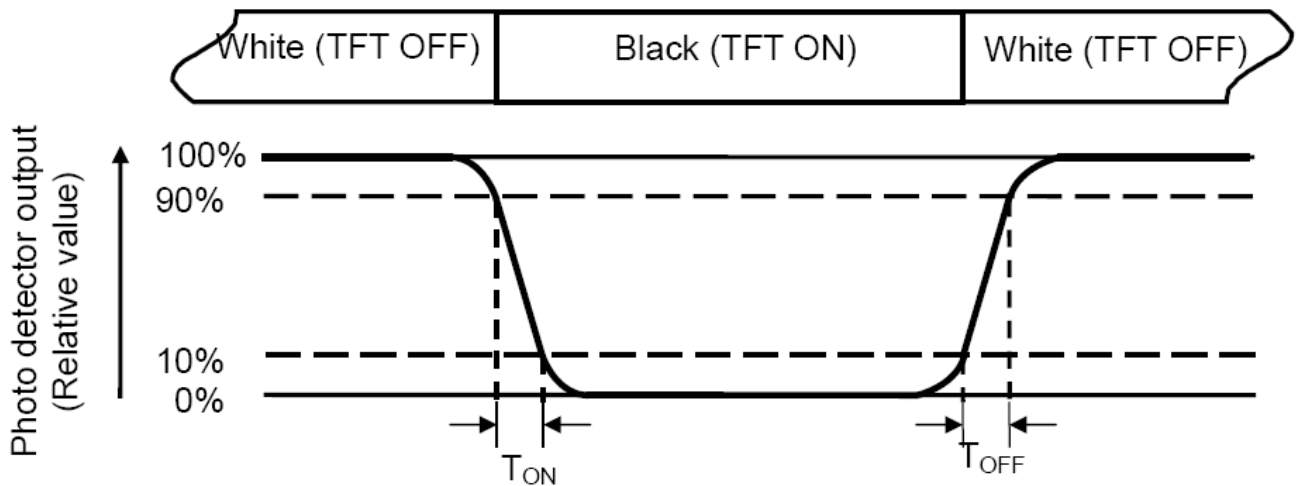

Figure 4.3 Definition of response.

Note 4: Definition of contrast ratio

$$\text{Contrast ratio (CR)} = \frac{\text{Luminance measured when LCD on the "white" state}}{\text{Luminance measured when LCD on the "black" state}}$$

Note 5: Definition of color chromaticity (CIE1931)

Color coordinates measured at center point of LCD.

Note 6: All input terminals LCD panel must be ground while measuring the center area of the panel.

Note 7: Definition of Luminance Uniformity

Active area is divided into 9 measuring areas (Refer to Fig. 4.4).Every measuring point is placed at the center of each measuring area.

$$\text{Luminance Uniformity (Yu)} = \frac{B_{min}}{B_{max}}$$

L-----Active area length W----- Active area width

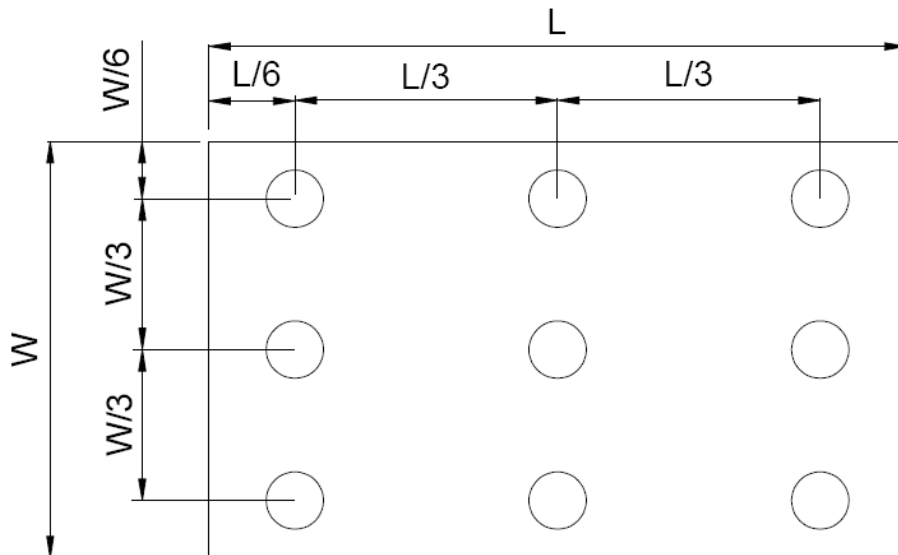

Figure 4.4 Definition of measuring points.

B_{max} : The measured maximum luminance of all measurement position.

B_{min} : The measured minimum luminance of all measurement position.

5. RELIABILITY TEST

Item	Test Condition Item	Remark
High temperature storage	Ta= 80 °C 96hrs	Note 1 Note 4
Low temperature storage	Ta=-30 °C 96hrs	Note 1 Note 4
High temperature operation	Ts= 70 °C 96hrs	Note 2 Note 4
Low temperature operation	Ts=-20°C 96hrs	Note 1 Note 4
High temperature/High humidity operation	90% RH 50°C 96hrs	Note 4
Thermal Shock	-20°C/30 min ~ +60°C/30 min for a total 5 cycles, Start with cold temperature and end with high temperature.	Note 4
Vibration test	Freq:10~55~10Hz Amplitude:0.75mm 30min for each direction of X,Y,Z (1.5 hours for total)	
Package drop test	Height:60 cm 1 corner, 3 edges, 6 surfaces	
Electro static discharge	R: 330 Ω C:150pF Contact discharge: ±2K	Note 5

Note 1: Ta is the ambient temperature of samples.

Note 2: Ts is the temperature of panel's surface.

Note 3: In the standard condition, there shall be no practical problem that may affect the display function. After the reliability test, the product only guarantees operation, but don't guarantee all of the cosmetic specification.

Note 4: Before cosmetic and function test, the product must have enough recovery time, at least 2 hours at room temperature.

Note 5: Sample quantity no less than 3 pcs. Discharge no less than 5 times.

Contact discharge on bezel. For those without bezel, this test is not applicable

If the LCM is working abnormally during test but can recover after reset or after 2 hours recovery, the LCM is considered OK.

6. PRECAUTION FOR USING LCM

1. When design the product with this LCD Module, make sure the viewing angle matches to its purpose of usage.
2. As LCD panel is made of glass substrate, dropping the LCD module or banging it against hard objects may cause cracking or fragmentation. Especially at corners and edges.
3. Although the polarizer of this LCD Module has the anti-glare coating, always be careful not to scratch its surface. Use of a plastic cover is recommended to protect the surface of polarizer.
4. If the LCD module is stored below specified temperature, the LC material may freeze and be deteriorated. If it is stored above specified temperature, the molecular orientation of the LC material may change to Liquid state and it may not revert to its original state. And also excessive temperature and humidity could cause polarizer peel off or bubble. Therefore, the LCD module should always be stored within specified temperature and humidity range. If the LCD modules will be stored for a long time, the recommend temperature/humidity for the storage environment is:
Temperature : 15°C ~ 35°C / Relatively humidity: ≤80%
5. Meanwhile please follow other requirements below for storage:
 - Store with no touch on display surface by the anything else. If possible, store the LCD in the packaging situation when it was delivered.
 - If the original package is opened, please store in an anti-static polyethylene bag and seal it so as not to get fresh air outside enter into it.
 - LCD modules shall be stored in a dark place. And it shall not be exposed to sunlight nor fluorescent light in storage.

Note: If the storage time is over 1 year, the golden fingers of FPC might be slightly oxidized, but it won't affect the electrical performance, customer can use rubber to clean the golden fingers before assembly or directly assemble the display.

6. Saliva or water droplets must be wiped off immediately as those may leave stains or cause color changes if is remained there for a long time. And water vapor will cause corrosion of ITO electrodes. If the surface of LCD panel needs to be cleaned, wipe it swiftly with cotton or other soft dry cloth. If it is not still clean enough, blow a breath on the surface and wipe again. If needed, please just moisten cloth with one of the following solvents:
 - Isopropyl alcohol
 - Ethyl alcoholSolvents other than those mentioned above may damage the polarizer. Especially, do not use the following:
 - Water
 - Ketone
 - Aromatic solvents

7. The module should be driven according to the specified ratings to avoid malfunction and permanent damage. Applying DC voltage cause a rapid deterioration of LC material. Make sure to apply alternating waveform by continuous application of the M signal. Especially the power ON/OFF sequence should be kept to avoid latch-up of driver LSIs and DC charge up to LCD panel.

8. Mechanical Considerations

- a) LCM are assembled and adjusted with a high degree of precision. Avoid excessive shocks and do not make any alterations or modifications. The following should be noted.
- b) Do not tamper in any way with the tabs on the metal frame.
- c) Do not modify the PCB by drilling extra holes, changing its outline, moving its components or modifying its pattern.

9. Static Electricity

- a) Operator

Wear the electrostatics shielded clothes because human body may be statically charged if not ware shielded clothes. Never touch any of the conductive parts such as the LSI pads; the copper leads on the PCB and the interface terminals with any parts of the human body.

- b) Equipment

There is a possibility that the static electricity is charged to the equipment, which has a function of peeling or friction action (ex: conveyer, soldering iron, working table). Earth the equipment through proper resistance (electrostatic earth: 1×10^8 ohm).

Only properly grounded soldering irons should be used.

If an electric screwdriver is used, it should be well grounded and shielded from commutator sparks.

The normal static prevention measures should be observed for work clothes and working benches; for the latter conductive (rubber) mat is recommended.

c) Floor

Floor is the important part to drain static electricity, which is generated by operators or equipment.

There is a possibility that charged static electricity is not properly drained in case of insulating floor. Set the electrostatic earth (electrostatic earth: 1×10^8 ohm).

d) Humidity

Proper humidity helps in reducing the chance of generating electrostatic charges. Humidity should be kept between 50%RH and 80%RH.

e) Transportation/storage

The storage materials also need to be anti-static treated because there is a possibility that the human body or storage materials such as containers may be statically charged by friction or peeling.

The modules should be kept in antistatic bags or other containers resistant to static for storage.

f) Soldering

Soldering anything to this TFT display would void the warranty.

g) Others

The laminator (protective film) is attached on the surface of LCD panel to prevent it from scratches or stains. It should be peeled off slowly using static eliminator.

Static eliminator should also be installed to the workbench to prevent LCD module from static charge.

10. Operation

a) Driving voltage should be kept within specified range; excess voltage shortens display life.

b) Response time increases with decrease temperature.

c) Display may turn black or dark blue at temperatures above its operational range; this is (however not pressing on the viewing area) may cause the segments to appear "fractured".

d) Mechanical disturbance during operation (such as pressing on the viewing area) may cause the segments to appear "fractured".

11. If any fluid leaks out of a damaged glass cell, wash off any human part that comes into contact with soap and water. The toxicity is extremely low but caution should be exercised at all the time.

12. Disassembling the LCD module can cause permanent damage and it should be strictly avoided.

13. LCD retains the display pattern when it is applied for long time (Image retention). To prevent image retention, do not apply the fixed pattern for a long time. Image retention is not a deterioration of LCD. It will be removed after display pattern is changed.

14. Do not use any materials, which emit gas from epoxy resin (hardener for amine) and silicone adhesive agent (dealcohol or deoxym) to prevent discoloration of polarizer due to gas.

15. Avoid the exposure of the module to the direct sunlight or strong ultraviolet light for a long time.

7. MECHANICAL DRAWING

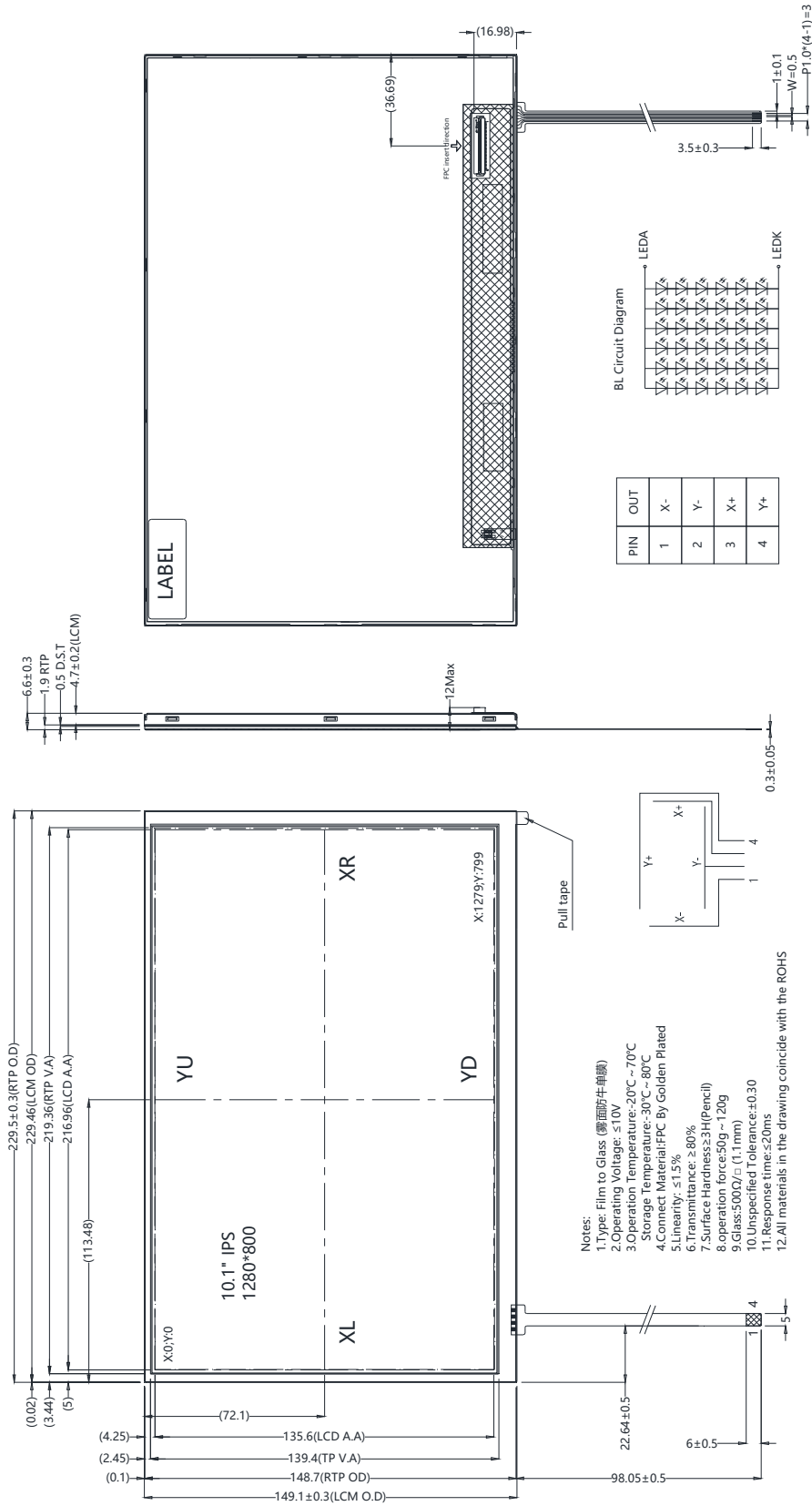

8. PACKAGE DRAWING

T.B.D

9. INSPECTION SPECIFICATION

1. SCOPE SPECIFICATIONS CONTAIN

- 1.1 DISPLAY QUALITY EVALUATION
- 1.2 MECHANICS SPECIFICATION

2. SAMPLING PLAN

UNLESS THERE IS OTHER AGREEMENT, THE SAMPLING PLAN FOR INCOMING INSPECTION SHALL FOLLOW MIL-STD-105E.

- 2.1 LOT SIZE: QUANTITY PER SHIPMENT AS ONE LOT (DIFFERENT MODEL AS DIFFERENT LOT).
- 2.2 SAMPLING TYPE: NORMAL INSPECTION, SINGLE SAMPLING.
- 2.3 SAMPLING LEVEL: LEVEL II.
- 2.4 AQL: ACCEPTABLE QUALITY LEVEL
 - MAJOR DEFECT: AQL=0.65
 - MINOR DEFECT: AQL=1.0

3. PANEL INSPECTION CONDITION

- 3.1 ENVIRONMENT:
 - ROOM TEMPERATURE: 25±5°C.
 - HUMIDITY: 65±5% RH.
 - ILLUMINATION: 300 ~ 700 LUX.
- 3.2 INSPECTION DISTANCE:
 - 35±5 CM
- 3.3 INSPECTION ANGLE:
 - THE VISION OF INSPECTOR SHOULD BE PERPENDICULAR TO THE SURFACE OF THE MODULE.
- 3.4 INSPECTION TIME:
 - PERCEPTIBILITY TEST TIME: 20 SECONDS MAX.

4. DISPLAY QUALITY



- 4.1 FUNCTION RELATED:
 - THE FUNCTION DEFECTS OF LINE DEFECT, ABNORMAL DISPLAY, AND NO DISPLAY ARE CONSIDERED MAJOR DEFECTS.
- 4.2 BRIGHT/DARK DOTS:

Defect Type	Specification	Major	Minor
Bright Dots	N ≦ 3		●
Drak Dots	N ≦ 4		●
Total Bright and Dark Dots	N ≦ 6		●

Note: 1:

The definition of dot: The size of a defective dot over 1/2 of whole dot is regarded as one defective dot.
 Bright dot: Dots appear bright and unchanged in size in which LCD panel is displaying under black pattern.
 The bright dot defect must be visible through 2% ND filter
 Dark dot: Dots appear dark and unchanged in size in which LCD panel is displaying under pure red, green, blue pattern.

4.3 Pixel Definition:

R	G	B	R	G	B	R	G	B			Dot Defect
R	G	B	R	G	B	R	G	B			Adjacent Dot Defect
R	G	B	R	G	B	R	G	B			Cluster

Note 1:



If pixel or partial sub-pixel defects exceed 50% of the affected pixel or sub-pixel area, it shall be considered as 1 defect.

Note 2:

There should be no distinct non-uniformity visible through 2% ND Filter within 2 sec inspection times.

ATM1010L1K-T (ZETTLER DISPLAYS) TFT MODULE SPEC VER1.1

4.4 Visual Inspection specifications:

Defect Type		Specification Size	Count (N)	Major	Minor
Dot shape (Particle, Scratch and Bubbles in display area) 		$D \leq 0.25\text{mm}$	Ignored		●
		$0.25\text{mm} < D \leq 0.5\text{mm}$	$N \leq 3$		
		$D > 0.5\text{mm}$	$N = 0$		
Newton Ring (Only for Touch panel)		$D \leq 70\text{mm}$	$N \leq 4$		●
		$D > 70\text{mm}$	$N = 0$		
TSP Fish Eyes (Only for Touch panel) (Bubble/Dent)		$0.1\text{mm} < D \leq 0.2\text{mm}$	$N \leq 4$		●
		$0.2\text{mm} < D \leq 0.3\text{mm}$	$N \leq 3$		
		$0.3\text{mm} < D \leq 0.4\text{mm}$	$N \leq 2$		
Line shape (Particles, Scratch, Lint and Bubbles in display area) 		$W \leq 0.01\text{mm}$	Ignored		●
		$0.01\text{mm} < W \leq 0.05\text{mm}$, and $L \leq 3\text{mm}$	$N \leq 3$		
		$W > 0.05\text{mm}$, or $L > 3\text{mm}$	$N = 0$		
Bubble in cell (active area)		It should be found by eyes			●
Bezel	Scratch	No harm			●
	Dirt	No harm			●
	Wrap	No harm			●
	Sunken	No harm			●
Label	No label	No			●
	Inverted label	No			●
	Broken	No			●
	Dirt	Word can be read			●
	Not clear	No			●
	Word out of shape	No			●
	Mistake	No			●
	Position	Be attached on right position			●
Screw	Not enough	No			●
	Limp	No			●
Connector	Connection status	No bend on PINs and damage			●
FPC/FFC	Broken	No			●

Note: Extraneous substance and scratch not affecting the display of image, for instance, extraneous substance under polarizer film but outside the display area, or scratch on metal bezel and backlight module or polarizer film outside the display area, shall not be considered as defective or non-conforming.